



THERMAGLAS™

MULTI-WALL POLYCARBONATE PANELS

Technical and Installation Guide

<i>General Description</i>	1
<i>Benefits of ThermaGlas 8mm Triple-Wall</i>	1
<i>ThermaGlas Technical Specifications</i>	1
<i>Light Transmission Terms (PAR, UV)</i>	3
<i>ThermaGlas UV2</i>	3
<i>Condensation Control</i>	3
<i>Internal Rib Spacing</i>	3
<i>Insulating Characteristics</i>	4
<i>Triple-Wall Cost Benefit</i>	5
<i>Chemical Compatibilities</i>	6
<i>Installation</i>	7
<i>Fastening Requirements</i>	11
<i>Sealing and Bonding</i>	13
<i>Cleaning and Care</i>	14
<i>Basic Warranty Info</i>	14
<i>Installation Accessories</i>	15
<i>ThermaGlas "Snap-Cap" Glazing System Application Details</i>	17

General Description

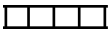

ThermaGlas® Twin-Wall polycarbonate provides clarity, durability and strength. Because the panels have an insulating air-filled space between the inner and outer wall, energy efficiency is increased. While 4mm, 6mm, 8mm, 10mm, and 16mm thicknesses are available, 8mm is the industry-standard thickness for most double layer polycarbonate products in the commercial greenhouse market. This is because it offers the best combination of strength, rigidity, good insulation value, and cost, as well as a wide variety of attractively priced glazing systems.

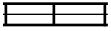



ThermaGlas Triple-Wall polycarbonate offers increased energy efficiency while also offering very good light transmission, which represents a major improvement over standard twin-wall products. While ThermaGlas triple-wall is available in a variety of thicknesses, including 8mm, 10mm and 16mm, the most widely used thickness is 8mm.

Benefits of ThermaGlas 8mm Triple-Wall over 8mm Twin-Wall

Feature	Benefit
14% more insulating efficiency	<ul style="list-style-type: none"> • Greater R.O.I. on glazing (see R.O.I. examples, page 6) • Reduced condensation • Less fluctuation of light transmission due to condensate formation
50% fewer internal vertical ribs	<ul style="list-style-type: none"> • Improved light transmission • Greater clarity • Better aesthetic appeal
A heavy exterior wall	<ul style="list-style-type: none"> • Good impact resistance
Compatibility with industry-standard 8mm glazing systems	<ul style="list-style-type: none"> • Lower cost for glazing systems • Greater variety of system choices

THERMAGLAS TECHNICAL SPECIFICATIONS

Dimensions										
Product	Thickness		Rib Spacing		Standard Widths		Weight		Lengths	Colors
	mm	in.	mm	in.	mm	in.	g/m ²	psf	ft.	
Twin-Wall 	4	5/32	6	~1/4	1200 1220 1810 1830 2100 ⁽¹⁾	47.25 48 71.25 72 82.68 ⁽¹⁾	777	0.16	24' in stock. Available up to 39' (3)	Clear Opal Bronze Solar Control
	6	1/4	6	~1/4			1300	0.27		
	8	5/16	10	~3/8			1500	0.35		
	10	3/8	10	~3/8			1700	0.35		
Triple-Wall 	8 ⁽¹⁾	5/16	20	~13/16	1200	47.25	1700	0.35	24' in stock. Available up to 39' (2)	Clear Opal Bronze Solar Control
	10 ⁽¹⁾	3/8	20	~13/16			1990	0.41		
	16	5/8	20	~13/16			2670	0.55		

(1) 2100mm (82.68") wide panels not available in all thicknesses.

(2) Please note that panels longer than 20' are not recommended due to expansion and contractions and also may require a longer lead-time and additional freight surcharges.

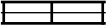
Thermal		Value		Test Method
No. of Layers	Panel Thickness	R-Factor	U-Factor	
Twin-Wall 	4mm	1.49	0.67	ASTM C-177
	6mm	1.62	0.62	
	8mm	1.72	0.58	
	10mm	1.89	0.53	
Triple-Wall 	8 mm	1.99	0.50	
	10 mm	2.08	0.47	
	16 mm	2.36	0.42	
Optimal Service Temperature Range		-40° F to +248° F (- 40° C to ± 120° C)		
Maximum Service Temperature		270° F (132° C)		
Minimum Service Temperature		- 103° F (-75° C)		
Heat Deflection Temperature (Load:264 PSI)		275° F		
VICAT Softening Temperature (Load:2.2 lb.)		300° F		ASTM D-1525
Coefficient of Linear Thermal Expansion		3.6 x 10 ⁻⁵ in./ in.°F		ASTM D-696
Thermal Conductivity (BTU-in/hr-ft ² - °F)		1.45		ASTM C-177

Mechanical			
Tensile Strength At Yield (0.4 in./ min.)		9,400 psi	ASTM D-638
Tensile Strength At Break (0.4 in./ min.)		8,800 psi	
Elongation At Yield (0.4 in./ min.)		6%	
Elongation At Break (0.4 in./ min.)		> 90%	
Tensile Modulus of Elasticity (0.4 in./ min.)		350,000 psi	
Flexural Modulus (0.052 in./ min.)		380,000 psi	ASTM D-790
Flexural Strength At Yield		14,500 psi	ASTM D-790
Rockwell Hardness		118 R Scale	ASTM D-785
Density		75 lb/ft ³	ASTM D-792
Specific Gravity		1.2 g/cc	ASTM D-792

Optical								
Property	Test Method	Panel Thickness	Clear		White Opal		Gray	
			Twin Wall	Triple Wall	Twin Wall	Triple Wall	Twin Wall	Triple Wall
PAR Light Transmission <i>(see next page for more information about PAR light)</i>	ASTM D-1003	4mm	82%		30		35%	
		6mm	80%		20		35%	
		8mm	80%	76%	45%	45%	35%	35%
		10mm	79%	76%	30%	45%	35%	35%
		16mm		76%		35%		35%
Refractive Index	ASTM D-542	All thicknesses	1.59					
Yellowness Index	ASTM D-1925	All thicknesses	< 1					

Fire / Ignition / Smoke	Value	Test Method
Flammability Rating	CC1 †	ASTM D-635-74
Self Ignition	1000° F	ASTM D1929
Flash Ignition	930° F	ASTM D1929
Smoke Density (%)	8.6%	ASTM D2843
Smoke Developed	350 (Class A)	ASTM E-84
Flame Spread	15 (Class A)	ASTM E-84
Vertical Burning	UL94-5VA	UL94-1998

† Select products apply

LIGHT TRANSMISSION

PAR Light Transmission

An acronym for photosynthetically active radiation. Of the sun's total spectrum of energy, this is the visible portion and is regarded by most horticulturists as being critical for proper plant growth and development. Within this band of energy, colors occur in the sequence seen in a rainbow ranging from violet through blue and green, yellow and orange to red.

PAR Light is the spectrum of light that is utilized by the plant. A measure of visible light intensity (400-700 nanometers) obtained by using a specialized light meter. PAR is simply a count of photons falling upon a surface in a given time and is reported as "micro Mols per square meter per second" ($\mu\text{Mols}\cdot\text{m}^2\cdot\text{sec}$). Quantum meters report all wavelengths between 400 and 700 nm, however, they report only light intensity and do not account for spectral quality.

Ultraviolet Light Transmission (UV)

ThermaGlas incorporates a co-extruded protective UV layer. This layer acts as a barrier and helps to prevent degradation of the panel itself. Co-extrusion offers dramatically superior durability when compared to other types of UV protective barriers and ensures against de-lamination or oxidation. 99.5% of the sun's harmful UV radiation is blocked by ThermaGlas, resulting in a panel that is highly weather resistant, durable, and non-yellowing.

ThermaGlas UV2® *(with optional double-sided UV protection)*

ThermaGlas UV2 panels are manufactured with built-in UV protection on both sides of the panel. This panel should be used for open roof greenhouses or fully exposed exterior walls or partitions. UV protection prevents yellowing and helps maintain strength, impact resistance, and clarity over time.

Condensation Control

ThermaGlas triple wall has double air space and higher R-Factor, which reduces condensation formation. The double tempering of the air results in lower inside/outside temperature differentials, both within the panel (the primary location of condensation formation on double wall panels), as well as on the underside of the panel. Reduced indoor / outdoor temperatures results in reduced condensation. When condensate is present, the droplets reflect light away from the glazing surface. By minimizing condensate formation, light transmission remains constant. Triple-wall minimizes condensate formation better than twin-wall by virtue of the fact that it has two air spaces instead of one.

Internal Rib Spacing

Twin Wall: Conventional 8mm double-wall products have very close internal rib spacing, approximately 10mm. This results in very "busy" looking panels, which are lacking in aesthetic appeal.

Triple Wall: The 100% wider rib spacing of ThermaGlas Triple-Wall provides greatly improved "see-through" qualities, making it a far more attractive choice for use in vertical wall applications, especially in retail oriented facilities. This also keeps that light transmission near to that of twin-wall, in spite of the added layer.

INSULATING CHARACTERISTICS

General Insulating Information

Heat loss occurs when heat transfers from one warmer surface to another colder surface. As an example, if you were to put your warm hand on a cool ceramic tile for a few minutes heat from your body would begin to transfer to the tile and the tile would begin to get warmer. You could easily test this by removing your hand; touching another area of the tile and then quickly putting it back to the spot that your hand just warmed.

During winter months, heat also transfers from the warmer inner surface of greenhouse glazing materials to the colder outer surface (assuming that the greenhouse is enclosed and heated). There are a few weather related elements that can accelerate the heat transfer process: wind, temperature, and humidity.

Multi-wall materials increase energy efficiency by increasing the number of surfaces through which heat must transfer before it reaches the outside, as well as adding an air space in between the layers where heat can accumulate before it transfers through the next surface. The air becomes warmer within the air space, thereby slowing the transfer from the inner-most surface. Additional layers with additional air spaces will increase energy efficiency and reduce heat transfer. (Layers also affect light transmission. More on this later).

Standardized Measurements for Insulating Characteristics

Standardized procedures are used in the building and construction industry to determine the relative energy efficiency of most building products. Insulating values are typically stated in terms of U-value or R-value in the U.S.A., and K-value (the metric equivalent) everywhere else in the world. Where U-factor is concerned, a lower number indicates better energy efficiency. Where R-Factor is concerned, a higher number indicates better energy efficiency.

Insulating Values

Product	Profile	Thickness	R-Factor	U-Value
Twin-Wall		4mm	1.49	0.67
		6mm	1.62	0.62
		8mm	1.72	0.58
		10mm	1.89	0.53
Triple-Wall		8mm	1.99	0.50
		10mm	2.08	0.47
		16mm	2.36	0.42

Note: R-Factor – The higher the number the better insulator

U-Value – The lower the number the better insulator

For 14% More Energy Savings, Choose 8mm Triple Wall: The addition of an ultra-thin horizontal center wall results in ThermaGlas having two insulating air spaces instead of only one. This increases ThermaGlas insulating property by 14% compared to 8mm double wall panels. In most cases, the slight additional cost of ThermaGlas triple wall is fully recovered by reduced heating costs in from one to three years. Thereafter, the grower realizes big heating cost savings year after year (see table on next page).

TRIPLE WALL COST BENEFITS

What is the net effect of buying a product that costs slightly more, but which results in substantial savings on an on-going basis?

The table below answers this question conclusively. The data presents both the cost and the economic benefit of ThermaGlas 8mm Triple-Wall compared to double wall glazing. Three different size greenhouse ranges are used as examples. In order to cover a fairly wide spectrum of heat loss experience, three typical heat loss costs using double-wall coverings are assumed for each of the three ranges (acrylic and polycarbonate sheet and double poly film all have similar heat loss coefficients). If your heat loss cost experience varies from those shown, simply interpolate your heating cost to arrive at your Payback Period and Return on Investment.

Again, the starting point is the fact that ThermaGlas has an R-Factor of 1.99 compared with a Factor of 1.72 for double-wall materials. This R-factor differential corresponds directly to a heat loss reduction factor of 14%, the factor that is utilized in the Table. The Payback Period is the length of time it will take for your heating cost savings to pay for the slightly higher cost of ThermaGlas. After that period, you will be experiencing the annual Return on Investment indicated in the last column. *(Note: ROI does not include compounded interest or profit again).*

ThermaGlas Heating Cost Savings, Payback Periods and Returns on Investment*							
Ground Area (Sq. Ft.)	Heating Cost psf of Ground Area	Annual Heating Cost	Annual Savings @ 14%	ThermaGlas Required (Sq. Ft.)	Additional Cost for Triple-Wall*	Payback Period (Years)	Annual R.O.I.
A. Two 30' x 100' Gutter-Connected Greenhouses (6,000 Sq. Ft.)							
6,000	\$1.25	\$7,500	\$1,050	10,145	\$2,333	2.2	45%
6,000	\$1.00	\$6,000	\$840	10,145	\$2,333	2.8	36%
6,000	\$0.75	\$4,200	\$630	10,145	\$2,333	3.7	27%
B. Two 35' x 200' Gutter-Connected Greenhouses (14,000 Sq. Ft.)							
14,000	\$1.25	\$17,500	\$2,450	21,386	\$4,705	1.9	52%
14,000	\$1.00	\$14,000	\$1,960	21,386	\$4,705	2.4	42%
14,000	\$0.75	\$10,500	\$1,470	21,386	\$4,705	3.2	31%
C. Five 42' x 210' Gutter-Connected Greenhouses (44,000 Sq. Ft. = 1 Acre)							
44,000	\$1.25	\$55,000	\$7,718	58,233	\$12,229	1.6	63%
44,000	\$1.00	\$44,000	\$6,174	58,233	\$12,229	2.0	50%
44,000	\$0.75	\$33,000	\$4,631	58,233	\$12,229	2.6	38%

*The price differential between 8mm twin-wall and 8mm triple-wall; price differential may vary depending on the quantity purchased.

CHEMICAL COMPATIBILITIES

ThermaGlas Chemical Resistance, Compatible Sealants and Adhesives

ThermaGlas has good resistance to many chemicals, sealants and adhesives, however, some chemicals may harm the ThermaGlas sheets. Information about many compatible chemicals, sealants, and adhesives can be found by contacting Palram Americas' Horticultural Product Division, or by visiting the Palram Web site at:

<http://www.palramhort.com/compatibility.html>

Before using any chemical or accessory product in conjunction with ThermaGlas, you should confirm that it is compatible with polycarbonate. Ask the manufacturer of the accessory product to provide assurance that the product has been tested and approved for use with polycarbonate.

Palram can test products for compatibility, or provide support to manufacturers of accessory products to develop an in-house testing program.

To have products tested by Palram, please ship sample to the following address:

Palram Americas
Attn: Product Compatibility Testing
Arcadia West Industrial Park
9735 Commerce Circle
Kutztown, PA 19530

- For liquid materials, supply 4 to 5 oz.
- Washer or spacer samples should be submitted in groups of 5 pieces of each type.
- Fabrics, films, and rigid materials should be roughly 8" x 10" in size.
- Closures should be submitted in pieces roughly 8" long.

IMPORTANT!!! Please be certain to include a contact name, return address and phone number. If available, also indicate ingredients and manufacturing information.

NOTE: Palram can only confirm that the sample submitted for compatibility is compatible with ThermaGlas. Given that Palram has no control over the manufacturing of compatible products after testing, or the changes to raw materials used in the manufacturing process, Palram does not *guarantee or warranty* compatibility in any way. Before using any product, contact the manufacture to obtain their written assurance that it is compatible with ThermaGlas polycarbonate products. Failure to use a compatible adhesives, sealants, closures, washers, or any other accessory may void any and all warranties.

INSTALLATION

Storage and Handling

Panels can be stored outdoors without suffering damage from rain or snow. However, panels must not be exposed to direct sunlight while they are stacked. Stacks of three or more panels act as a solar heat collector and may incur heat stress damage, which is not covered by the warranty. The original white, watertight polyethylene package is sufficient to protect panels from this type of damage (do not confuse the packaging film mentioned here with protective masking film that is electrostatically adhered to each sheet). Do not stack heavy objects on the panels.



Avoid leaving the sheets in the rain, even if still wrapped, for extended periods, as water may condense inside the hollow core.

When necessary to store panels in the open, cover them with a white opaque polyethylene sheet, cardboard, or any insulating material, taking care to cover the pallet completely.

ThermaGlas panels should be transported and stored horizontally, on a flat, sturdy pallet whose dimensions are equal to or larger than the sheets themselves. The sheets must be secured and fastened to the pallet during transportation and handling at the site. It is possible to stack the sheets with the longer sheets at the bottom and the shorter on top, leaving no unsupported overhang.

While moving a pallet with a forklift, use fork extenders if necessary so the full width of the sheet is lifted. Using shorter forks on a wider pallet may cause damage to the sheets.

Panel Positioning/Which Side Goes Out?

ThermaGlas panels have a UV-protected exterior surface. The panels should include a label stating "This side out." If there is no label, look for a production stamp along the vertical edge of the panel. It will state which side of the panel is UV protected (UV protected side should be exposed to the sun).

IMPORTANT NOTE: DO NOT STEP OR WALK ON THERMAGLAS PANELS! Always use a scaffold or, at the very least, crawling boards (chicken ladders) to distribute the installer's weight across the panel. Be certain that the crawling boards span at least two purlins as the panels are not designed to accommodate localized stress caused by concentrated weight. Note that panels can puncture easily under localized pressure.

Scaffolds

It is best to apply ThermaGlas panels on the roof with a professional greenhouse roof scaffold. If scaffolding is not available, extension ladders or crawling boards, supported by the roof's structural elements, may be used. When using an extension ladder, lay the ladder on the roof with the legs resting in the gutter of the greenhouse. Extend the ladder the distance of the roof slope so that it is also supported by the ridge support.

Never step on the ThermaGlas panel between the purlins or in the middle of a framed glazing. In an emergency, step only on the area directly above purlins or structural framing, however, doing so may cause damage to the panel. Never step on the panels directly at the fastener and spacer as the soft sole of a shoe forcefully conforming to the fastener and spacer can cause undue localized stresses and will likely crack the panel.

Protective Masking Films (a.k.a., Protective Scrim)

ThermaGlas panels typically ship with a protective scrim on the UV protected side of the panel. In some cases, panels *may* ship with a protective scrim on *both* sides of the panels. Color of the scrim may vary depending on the factory production and product type.

Should the panels be provided with a protective scrim on both surfaces, remove the underside masking or scrim just prior to the actual installation.



Remove the outer side or exterior protective film as soon as the installation of the whole glazed area is completed. This film should be removed shortly after installation. Failing to remove the film and exposing the film to direct sunlight may cause difficulties in removal due to deterioration of the film, and void the warranty.

Protecting Against Dust Infiltration

The upper end of ThermaGlas panels should be sealed using adhesive backed ThermaGlas Solid tape. This prevents moisture and contaminants from entering the panel cavities.

ThermaGlas
Solid Tape

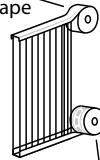

ThermaGlas
Permeable Tape

Allowing for Condensation Drainage

The lower end of ThermaGlas panels should be covered using adhesive backed ThermaGlas Permeable Tape. This allows condensation moisture to escape, but keeps dust and contaminants out.

Sealing tapes should be protected from mechanical harm by using a suitable glazing system (i.e., bottom channel, ridge, U-profile, etc.)

Weep holes should be drilled in the bottom glazing member so that moisture can escape (1/8" diameter weep hole every 18"-24").

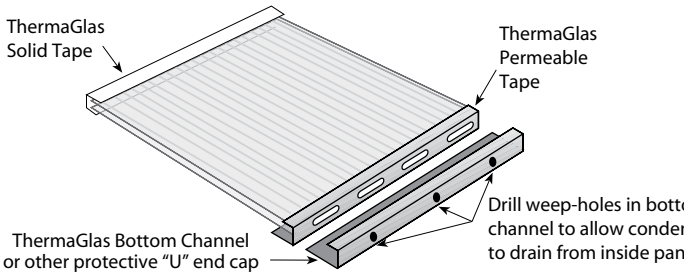

Cutting Panels

ThermaGlas panels can be cut with a power circular saw equipped with a triple chip fine-tooth blade. Dust can be removed from the flutes by applying compressed air or with a vacuum. A razor knife can be used with cuts made on both surfaces of the sheet to ensure a clean cut.

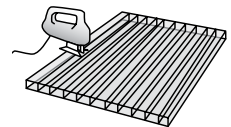

A hand hacksaw may also be used for local cutting. For short and complex cuts, a band saw or jigsaw can be used taking care to advance the blade slowly. A special cutting-wire hand tool may also be used to make lengthwise cuts.

Panel Orientation

ThermaGlas sheets should be installed with the rib channels in the direction of the slope for roof installation or in a vertical position for windows or walls. This position reduces accumulation of dirt inside the sheet and ease gravity drainage of condensation moisture.

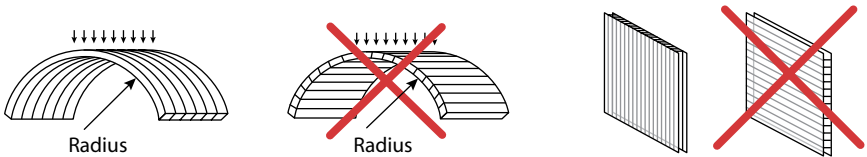

Distance Between Purlins (horizontal roof support members)

Based on two-sided clamping method with mid-sheet support(s) for greenhouse applications

		Recommended Span Under Given Load (Wind / Snow Load)								
Profile	Panel Thickness	10 psf	15 psf	20 psf	25 psf	30 psf	35 psf	40 psf	45 psf	50 psf
		Purlin Spacing (inches)								
Twin-Wall	6mm	31.5	27.6	25.6	24.4	23.6	22.8	22.4	22.2	22.0
	8mm (1.5 KG/M ²)	39.4	35.4	31.5	29.5	28.9	28.3	28.0	27.8	27.6
	8mm (1.7 KG/M ²)	41.3	37.4	33.5	31.5	30.9	30.3	29.9	29.7	29.5
	10mm	49.2	42.5	37.8	35.4	33.7	32.7	31.9	31.5	31.3
Triple-Wall	8mm	38.4	34.4	30.7	28.9	28.0	27.2	26.6	26.2	26.0
	10mm	48.0	41.3	36.6	33.9	32.3	31.5	30.9	30.5	30.3
	16mm	63.0	55.1	49.2	45.3	42.3	40.4	39.4	38.8	38.6

Notes



1. The data is based on load tests on typical multi-wall sheets and additional extrapolations.
2. The data is based on a maximum deflection of 1/20 of the span (5%) using continuous, multi-span supports.
3. The data refers to mid-spans. The edge spans (lower and upper ends) should be smaller by about 20%.
4. The sheets can withstand even higher loads or wider span without failure, but the deflection may then grow to almost 1/10 the span (10%).

Distance between Girts (horizontal wall support members)

Vertical wall panels should have girt spacing no greater than 4 feet on center. Attachment should occur at the top and bottom of the panel. It is recommended that bottom edges of vertical ThermaGlas panels be affixed to glazing members, rather than simply burying the panel ends into the ground. This will minimize algae growth within the panel cavities.

Arch Radius Construction

ThermaGlas is sufficiently flexible to allow vertically positioned panels to conform to arched construction. However, when installing 8mm ThermaGlas, it is not recommended that panels be affixed to curved surfaces where the curve radius is less than 55 inches. Affixing the panel to tighter radii surfaces may result in local stress crazing and deterioration over time.

Product	Profile	Panel Thickness	Minimum Bending Radii		
			mm	ft.	in.
Twin Wall		6 mm	1,050	3.44	41.3
		8 mm	1,400	4.59	55.1
		10mm	1,750	5.74	68.9
Triple Wall		8mm	1,400	4.59	55.1
		10mm	1,750	5.74	68.9
		16mm	2800	9.18	110.2

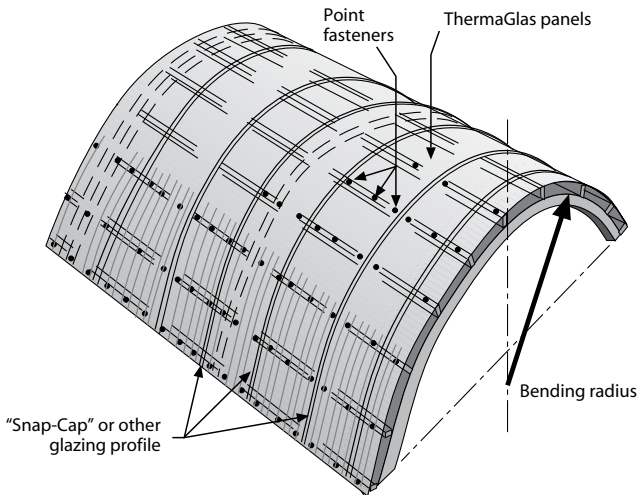

FASTENING REQUIREMENTS

Fasteners, Washers and Spacers

Use a screw that is appropriate for the thickness of the panel being applied (See section titled "Accessories" for more information). All screws should feature a corrosion resistant long-life coating to ensure durability. Stainless steel fasteners are recommended in extremely corrosive environments.

Note: It is recommended that Palram's fasteners and accessories be used with ThermoGlas. If products from other suppliers are used, it is imperative that the supplier test and warrant their products for compatibility with polycarbonate. See section titled "Chemical Compatibility" for more information.

ThermoGlas 8mm panels should be directly point fastened at each purlin location using #10 x 2" wood grip screw or #12 x 1 1/2" self-drilling tapping screw with a 1" (25.4 mm) Umbrella Washer. 1" ThermoGlas Spacer Washers should be used under the panel at every point fastener to keep panel elevated at the same height as the support rafter, bottom channel, or ridge, and to help reduce condensation drip at purlins.

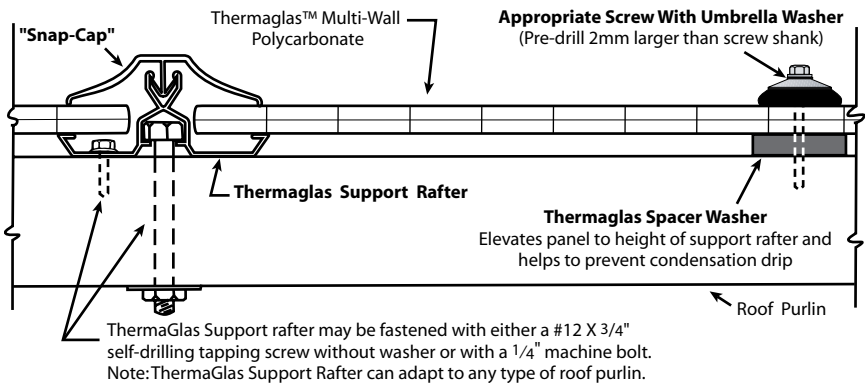

Pre-Drilling

A hole must be pre-drilled into each screw location. The diameter of that hole should be 2mm or 1/16" (2mm) larger than that of the screw, to allow for thermal expansion movements. Special attention should be given to drill all the required holes perpendicular to the face of the material.

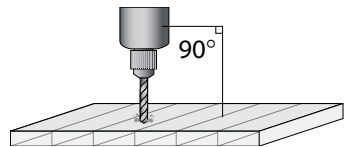

Over Tightening

An electric screwdriver with an adjustable clutch should be used to tighten screws.

It is imperative that over tightening be avoided in order to avoid undue stresses, which would cause premature failure and buckling of the sheet.

Be certain to insert the screws perpendicular to the material face, as inclined insertion could damage the sheet and/or result in leaks.



INCORRECT
Overtightened

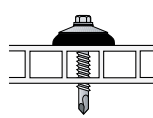

CORRECT



INCORRECT
Non-Perpendicular
drilling and insertion

Fastener Spacing

At intermediate purlins:

The sheets have to be fastened to the purlins by fastening screws, inserted along the supporting purlins, spaced about 24" (600 mm) apart, and 12" (30 mm) from the Support Rafter and Snap-Cap.

At panel ends:

If panel ends are inserted into glazing profiles with channel recesses designed to accommodate polycarbonate (at ridge, gutter or eave), fasteners are optional, but are highly recommended when wind or snow loads can be excessive. If fasteners are used at these points, placement should be the same as at intermediate purlins.

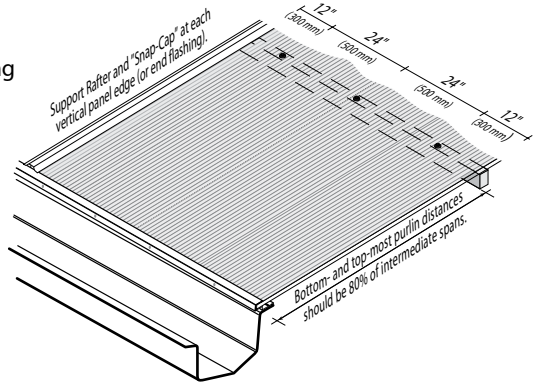

When panel end over hangs eave:

Along the edge purlin (or gutter) where the panel is not inserted into a channel recess, the fastening screws should be spaced about 12" (300 mm) apart.

Permeable Tape and a Protective U-Channel should be used for this type application.

Note: Panel ends should not over hang the eave by more than 3" (76mm).

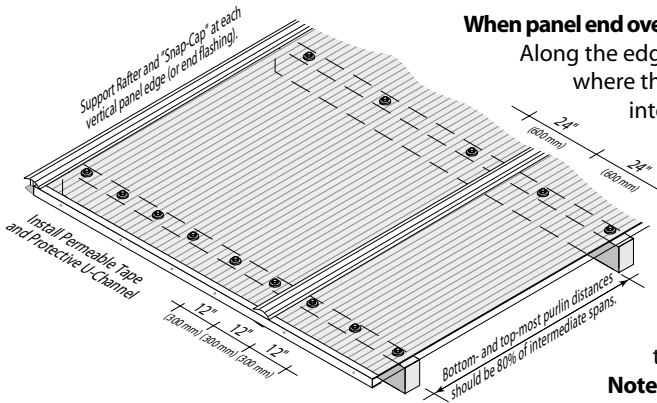

Along vertical edges of panel:

Fasteners are not necessary along the vertical edges of the panel. Securing the vertical edges of the panels is achieved with ThermaGlas Support Rafter and "SnapCap", ThermaGlas "H" Profiles, or other similar glazing system components.

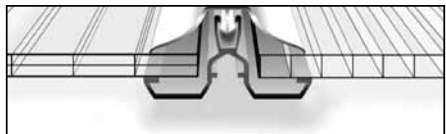

SEALING AND BONDING

Sealants

Only compatible silicone sealants should be used with ThermaGlas panels if required. Please visit the website at <http://www.palramhort.com/compatibility.html> to view an updated list of compatible silicones and sealants. To provide 100% assurance of compatibility use SunSeal® adhesive sealant, available from Authorized Palram Dealers.

Silicone sealants are not typically needed when installing ThermaGlas panels. However, if there is a need to seal odd cuts or gaps approved silicone sealants can be used to seal these gaps.

Sealing is recommended with ThermaGlas ridge extrusions, ThermaGlas vent header, and ThermaGlas Bottom Channel. Place a bead of sealant between the inserted panel and the profile. (See drawings below). This will prevent moisture and dirt to accumulate between the profile and panel.

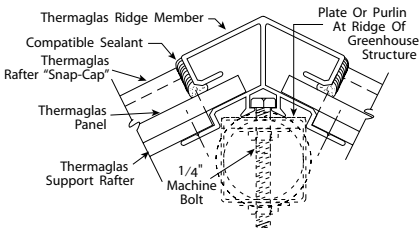

*Compatible silicone sealant to
ThermaGlas ridge profiles*

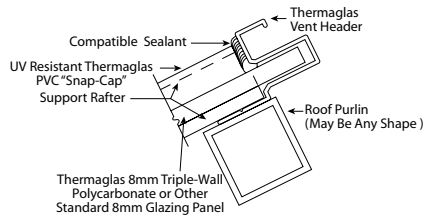

*Compatible silicone sealant to
ThermaGlas Vent Header profile*

Shade Compounds

To ensure 100% compatibility, Palram recommends the use of SolarFrost™ Liquid Shading for additional temporary or seasonal shading. Contact your Palram Authorized Dealer for more information about SolarFrost or other brands of compatible liquid shade.

IMPORTANT NOTE: Many typical greenhouse shading compounds are aggressive to polycarbonate. **WARNING:** Shading materials containing vinyl binders or organic solvents are aggressive to ThermaGlas and should be avoided.

Contact the manufacturer of the shade compound you wish to use and gain their approval for use with polycarbonate. Palram maintains no control over the manufacturing of commercially available shade compounds – or subsequent changes to those products over time – and therefore cannot recommend any particular product for use.

Shade compound manufacturers are encouraged to contact Palram for assistance in developing a compatibility-testing program. Palram can perform preliminary tests to determine if a product is aggressive to polycarbonate. See section titled "Chemical Compatibility" in this booklet for more information.

CLEANING AND CARE

General Cleaning

Cleaning of ThermaGlas panels is important to yield long-term results and maintain sufficient light transmission of panels. Self-cleaning by rain is usually sufficient. If required, use diluted mild household detergents for additional cleaning. Make sure the detergent contains no abrasives or solvents. Pre-wash with warm water, then wash area to be cleaned with a soft sponge or brush, preferably with hot water, until clean. Rinse with water and dry with a soft non abrasive cloth.

Heavy Oils or Tar Stains

Heavy oil or tar stains can be removed with an ethyl alcohol watery solution. Rub the area gently with a soft rag. Follow with general cleaning as stated above, rinsing thoroughly with water before drying.

Cleaning Large Areas

Large areas may be professionally washed with a high-pressure water jet, possibly adding a mild compatible detergent, and/or steam jet. Avoid allowing the spray tip to come too close to the panel. Pressure washers often have enough pressure at the spray tip to penetrate or tear the panel.

Avoid cleaning the panel when dry, as the sand and dust particles cling to the exterior of the panel and may scratch the surface (*minor surface scratches will not damage the panel, the scratches will simply reduce optical clarity*).

Avoid repeated sliding of sheets over each other, even when protected by the protective film. This action generates an electrostatic charge in the sheet, attracting dirt and dust and hindering cleaning.

See section in this booklet titled "Chemical Compatibility" for other important information.

WARRANTIES





ThermaGlas Warranties



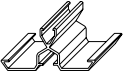

- Against Yellowing: 10-year limited warranty
- Condensate Control: 10-year limited warranty
- Hail: 10 year limited warranty

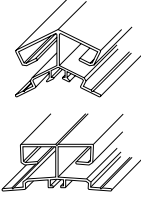
See printed warranty for details. Contact Palram or your Authorized Dealer for printed Warranty.

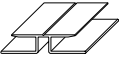
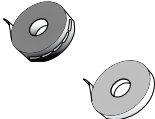
ACCESSORIES AVAILABLE FROM PALRAM AND ITS DEALERS

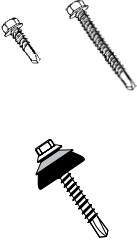
The installation accessories shown in this booklet are available from Authorized Palram Dealers. All items have been tested for compatibility with polycarbonate. Palram Authorized Dealers may also carry their own line of installation accessories. If you opt to use another manufacturer's installation accessories, check to ensure that the manufacturer's products and installation guidelines have been tested to be compatible with polycarbonate as those manufacturers will be required to provide support for those products.

	<p>ThermaGlas Support Rafter: Extra-strong aluminum vertical support member. Designed to receive "Snap Cap" member without having to drill holes or use threaded fasteners. For use with 8mm twin or triple wall panels. Also available for 16mm triple-wall panels.</p> <p>Standard lengths of 8', 10', 12', 16', 20' and 24'. Custom lengths are available for orders of 1,000 lineal feet or more.</p>
	<p>ThermaGlas SnapCap™: Attractive and functional member, which snaps down into the Support Rafter. Made of heavy-duty, UV and weather-resistant white PVC. Reduces thermal conduction compared to aluminum cap members.</p> <p>Standard lengths of 8', 10', 12', 16', 20' and 24'. Custom lengths are available for orders of 1,000 lineal feet or more.</p>
	<p>ThermaGlas Ridge (Sloped Roof): Heavy duty, non-corrosive aluminum member designed to receive upper end of 8mm twin or triple wall panels on sloped roofs (1:2 slope). Provides stop for upper end of Support Rafter and Snap-Cap.</p> <p>ThermaGlas Ridge (Arched Roof): Heavy duty, non-corrosive aluminum member designed to receive upper end of 8mm twin or triple wall panels on arched roofs. Provides stop for upper end of Support Rafter and Snap-Cap.</p> <p>Standard lengths of 12', 24'.</p>
	<p>ThermaGlas Vent Header: Non-corrosive aluminum member designed to be mounted on purlin member. Receives upper end of 8mm twin or triple wall panels and provides stop for upper end of Support Rafter and Snap Cap. Also acts as closure rail for vent bottom rail.</p> <p>Standard lengths of 12', 24'.</p>
	<p>ThermaGlas Bottom Channel: Versatile aluminum member for fastening lower ends of ThermaGlas panels at eave or gutter. Can also be used as termination strip for sidewall applications at top and bottom ends of vertical panels.</p> <p>Standard length of 12'.</p>
	<p>ThermaGlas "H" Profile: Strong aluminum vertical support member. Designed to receive the vertical sides of twin- and triple-wall panels. Available for 8mm thickness panels.</p> <p>Standard lengths 12', 24'.</p>
	<p>ThermaGlas Permeable Tape: For sealing lower ends of twin or triple wall panels. Prevents dust from entering panel cells, yet allows moisture to drain off.</p> <p>ThermaGlas Solid Sealing Tape: For sealing upper ends of twin or triple wall panels. Prevents dust from entering panel cells.</p>

	<p>Self-Drilling Tapping Screw:</p> <p>Hex head without washer #12 x 3/4" to 2". For fastening members to aluminum and steel.</p> <p>Hex head with 25mm (1") umbrella washer #14 x 1-1/2". For point fastening panels to aluminum and steel. This washer was designed specifically for use with polycarbonate. Extra thick umbrella washer is softer than most neoprene washers and has a concave underside to help prevent overtightening of screw. Washer helps to absorb stress that would otherwise be transferred to the panel, which could in turn cause premature failure.</p>
	<p>Woodgrip Screw:</p> <p>Hex head without washer #10 x 1" to 2". For fastening profiles directly to wood members.</p> <p>Hex head with washer #14 x 1-1/2". For point fastening panels to wood purlins. This washer was designed specifically for use with polycarbonate. Extra thick umbrella washer is softer than most neoprene washers and has a concave underside to help prevent overtightening of screw. Washer helps to absorb stress that would otherwise be transferred to the panel, which could in turn cause premature failure.</p>
	<p>ThermaGlas Spacer: Special adhesive-backed neoprene washer placed between ThermoGlas panel and greenhouse roof purlin at panel fastening points. Spacer elevates panel to level of ThermoGlas Support Rafter.</p>
	<p>Silicone Sealant</p> <p>Used to seal polycarbonate panels. Tested to be compatible with polycarbonate (note: many silicones are not compatible with polycarbonate). Offers better adhesive strength than most silicones.</p>

THERMAGLAS "SNAP CAP" GLAZING SYSTEM – APPLICATION DETAILS

General Snap-Cap Installation Overview

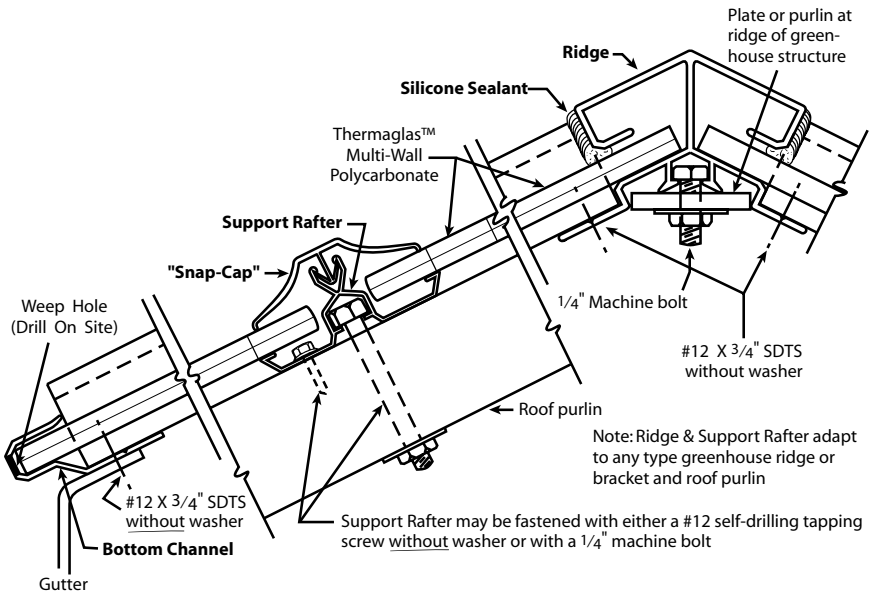
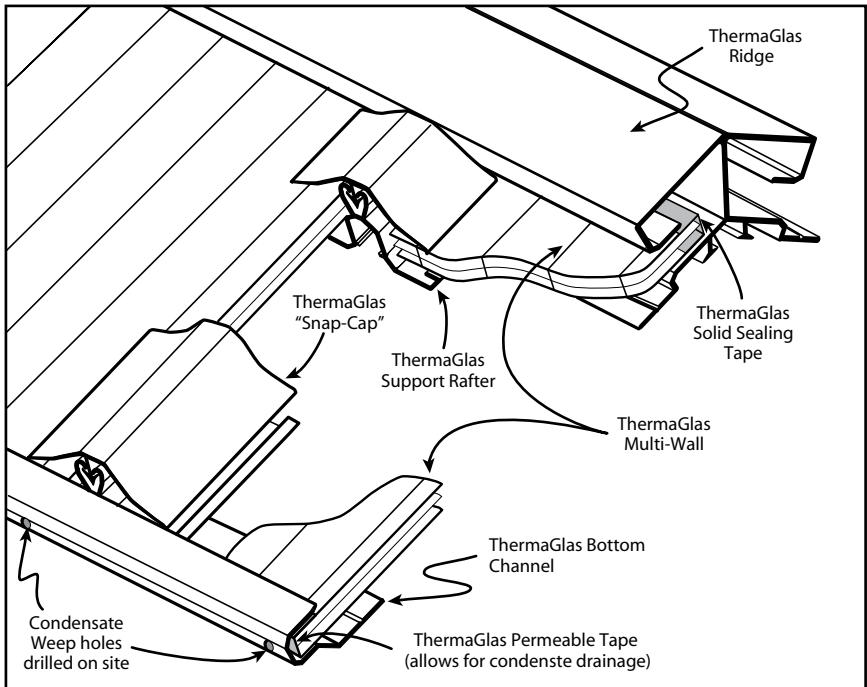

ThermaGlas "Snap Cap" Glazing System – Application Details (continued)

"Snap-Cap" Usage Overview

ThermaGlas Support rafters are made of aluminum for added support and rigidity. ThermaGlas "Snap-Cap" members are made of stabilized PVC that is compatible with polycarbonate. PVC offers excellent flexibility and offers better energy efficiency than aluminum, which translates to less heat loss.

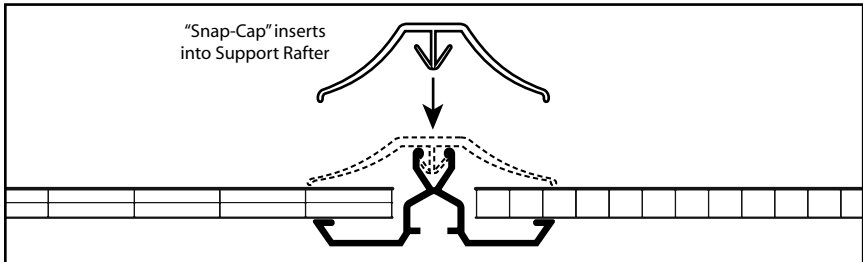

Detail at Various ThermaGlas Ridge Members

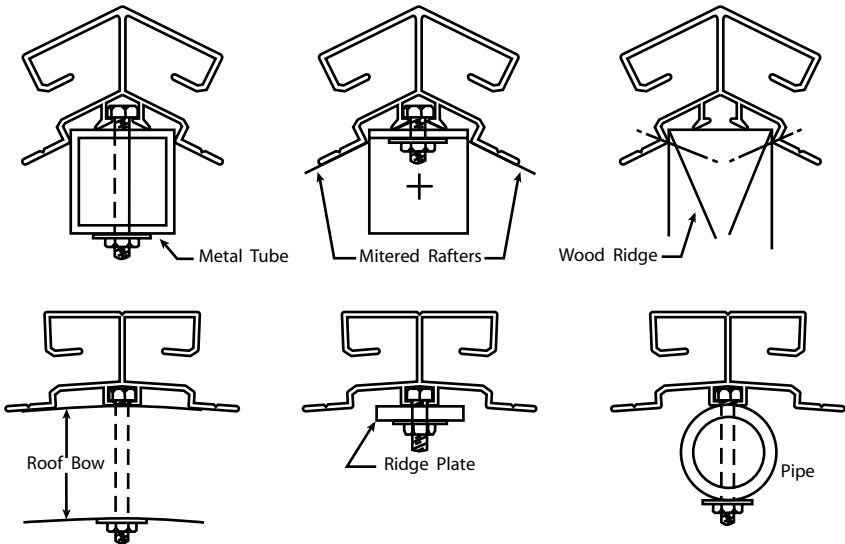



PALRAM AMERICAS
Horticultural Products Division
Formerly SPS International

9735 Commerce Circle, Kutztown, PA 19530
Phone: (800) 999-9459 • Fax: (610) 285-9918
Web: <http://www.palramhort.com>

